



# 中山市川狼五金制品厂

ZHONG SHAN CHUAN LANG LIGHTING CO., LTD

型号：铂狼二代50W-75W

外观图



线条图

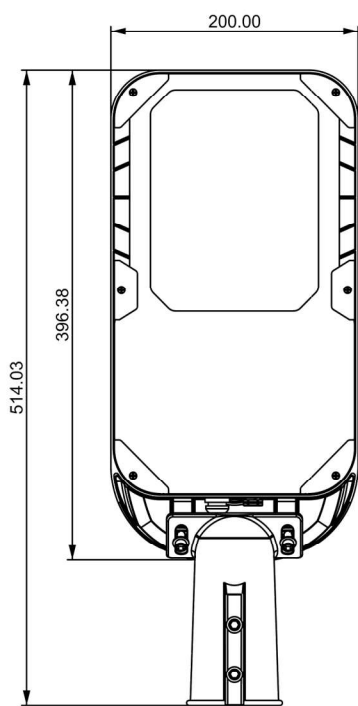

主视图

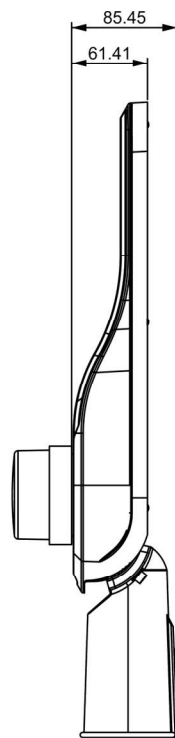

左视图

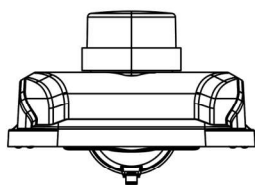

俯视图

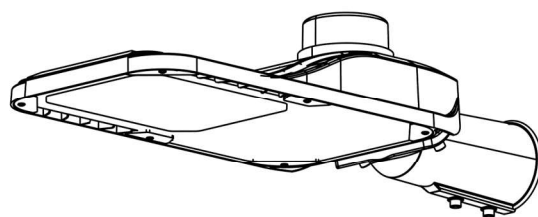

透视图

外形尺寸：220mm\*515mm\*85mm

铝基板-透镜

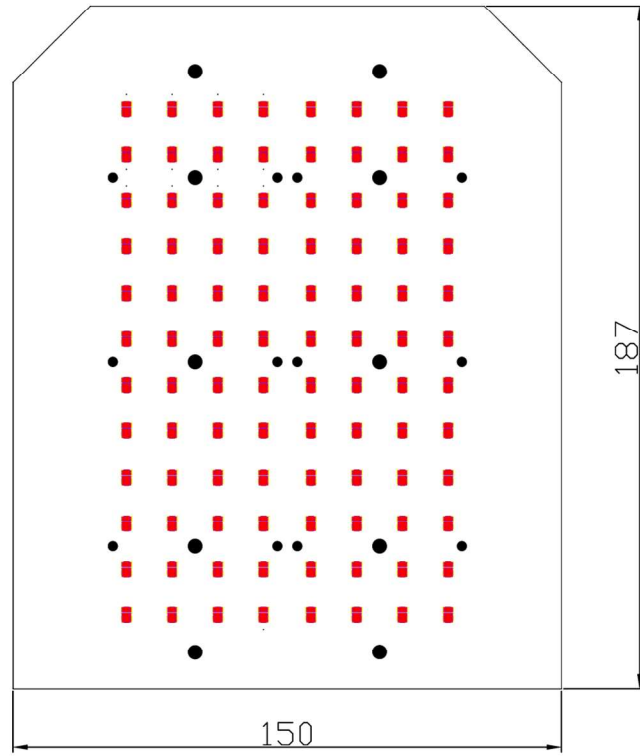

铝基板:150\*187\*T1.2 3030-8c12b

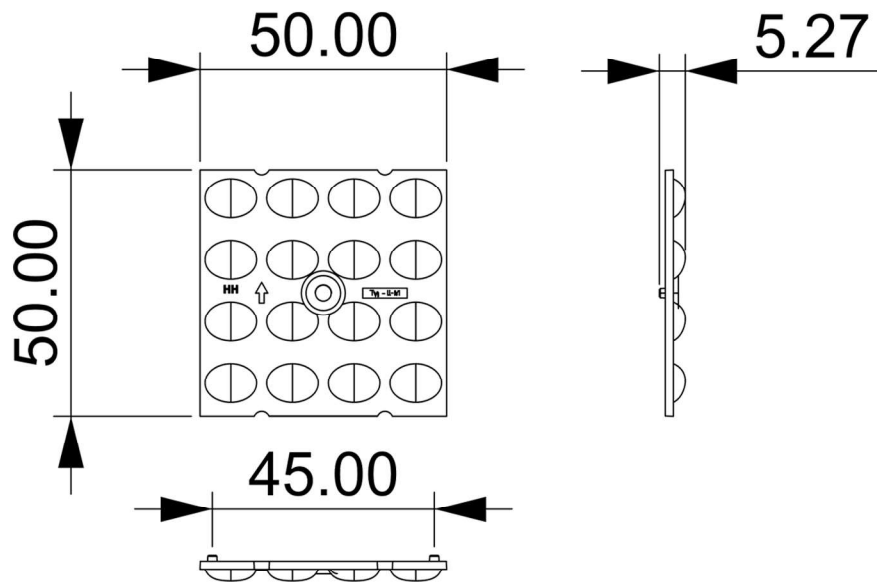

透镜:50mm\*50mm\*H5.27

透镜角度: 70\*140度

# 尺寸孔位

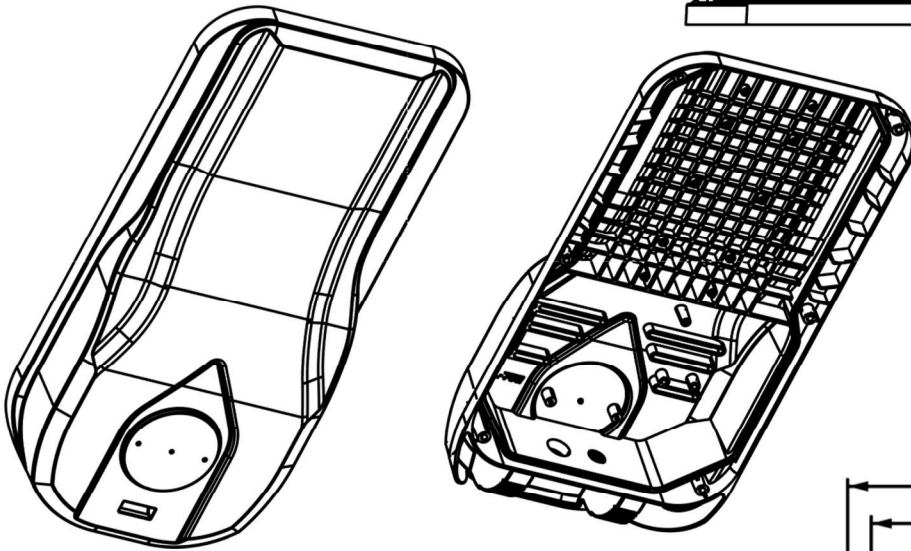
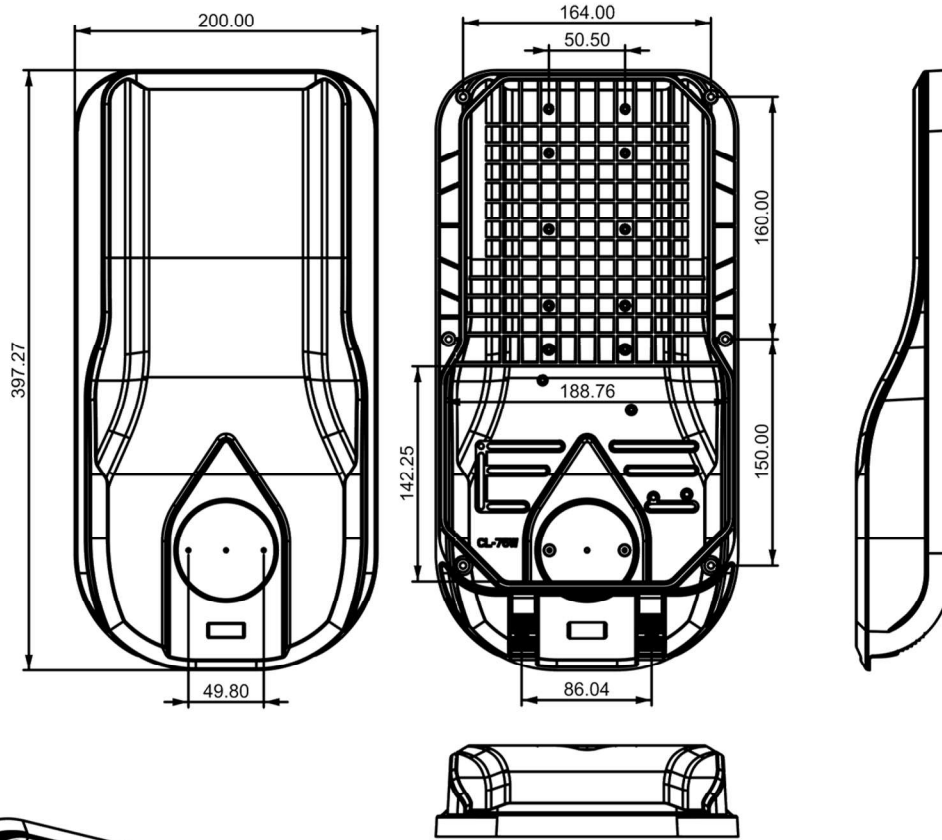

灯体尺寸：200mm\*397mm\*60mm

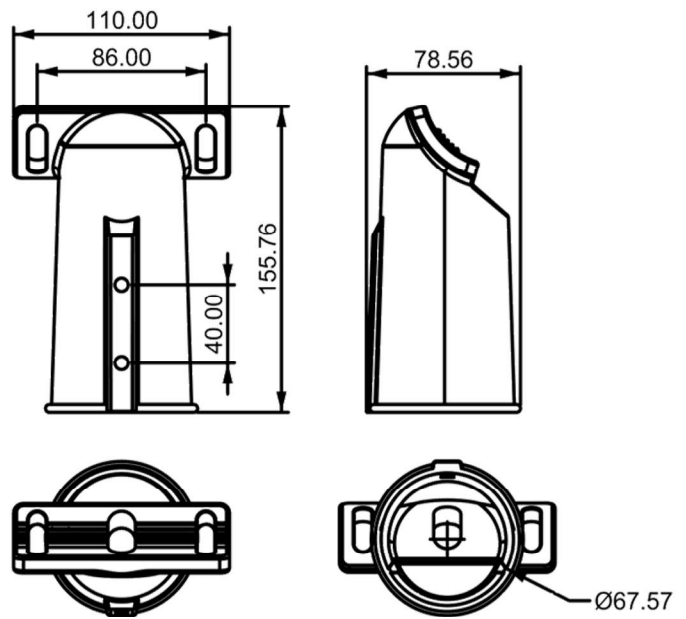

手柄尺寸：110mm\*78mm\*155mm

# 爆炸图

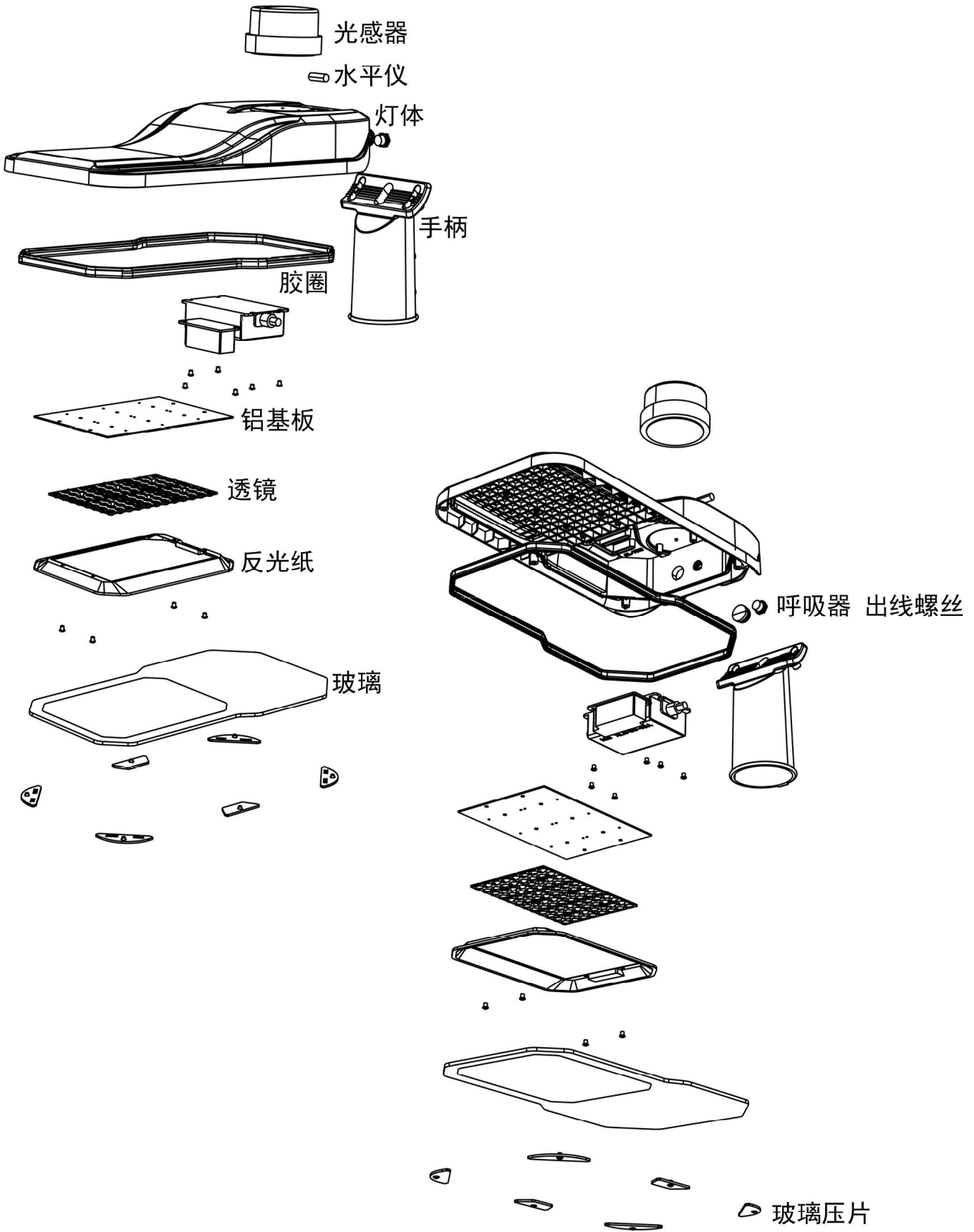

包装尺寸:

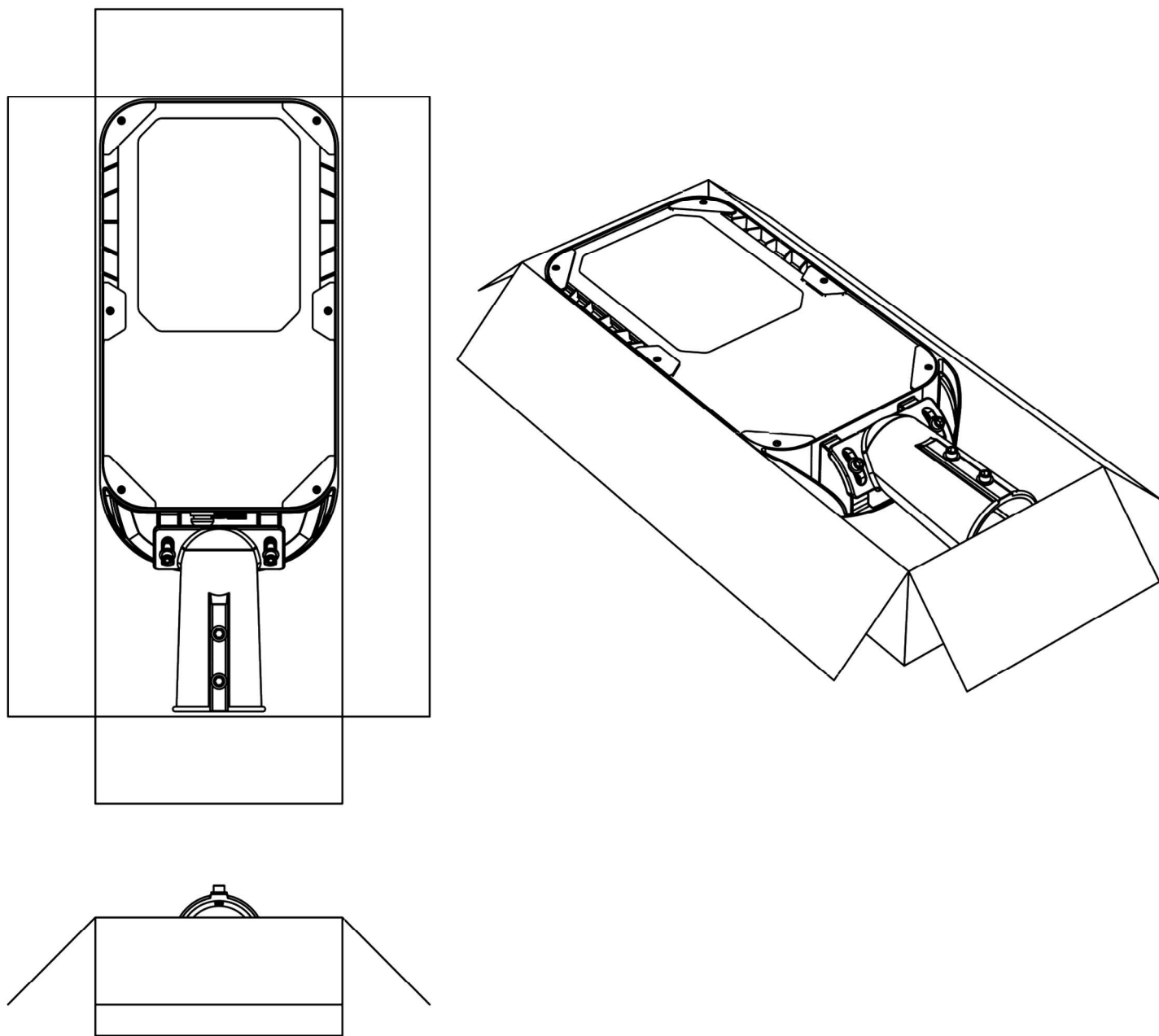

外箱尺寸: 210mm\*525mm\*100mm